



Complete system for welding prep, finishing and installation

Metabo solutions offer the highest productivity, quality and safety for all your metalworking needs.



metabo[®]
PROFESSIONAL POWER TOOL SOLUTIONS

Your power tool partner at every phase.

Metabo continues to be a reliable industry partner of the trades for almost a century. We offer power tool solutions for professionals to help master the challenges faced in metal processing; from deburring and rounding, weld seam prep, beveling, grinding to cutting and finishing.

Metabo is known for setting high standards. We produce tools and accessories that exceed today's safety requirements, quality expectations and productivity demands - it's what we do.

Discover what Metabo can do for you!

For all your finishing needs before and after welding

Weld seam prep and beveling



Proper preparation of metal before welding is critical for the achievement of good welds. Getting it right the first time saves costly rework and frustration. Only Metabo offers the range of tools to meet the needs of every shop. Metabo offers beveling tools and cutters for every application, assuring the lowest total cost and highest quality of weld preparation.

Grinding and cutting



Metabo angle grinders and abrasives are the tools of choice for highest productivity and safety. Grinding in difficult to reach areas presents safety challenges that only power tools like Metabo's flat head angle grinders can overcome. Also, safety features like Metabo's well known S-automatic safety slip clutch and mechanical brake help to keep operators safe on the job.

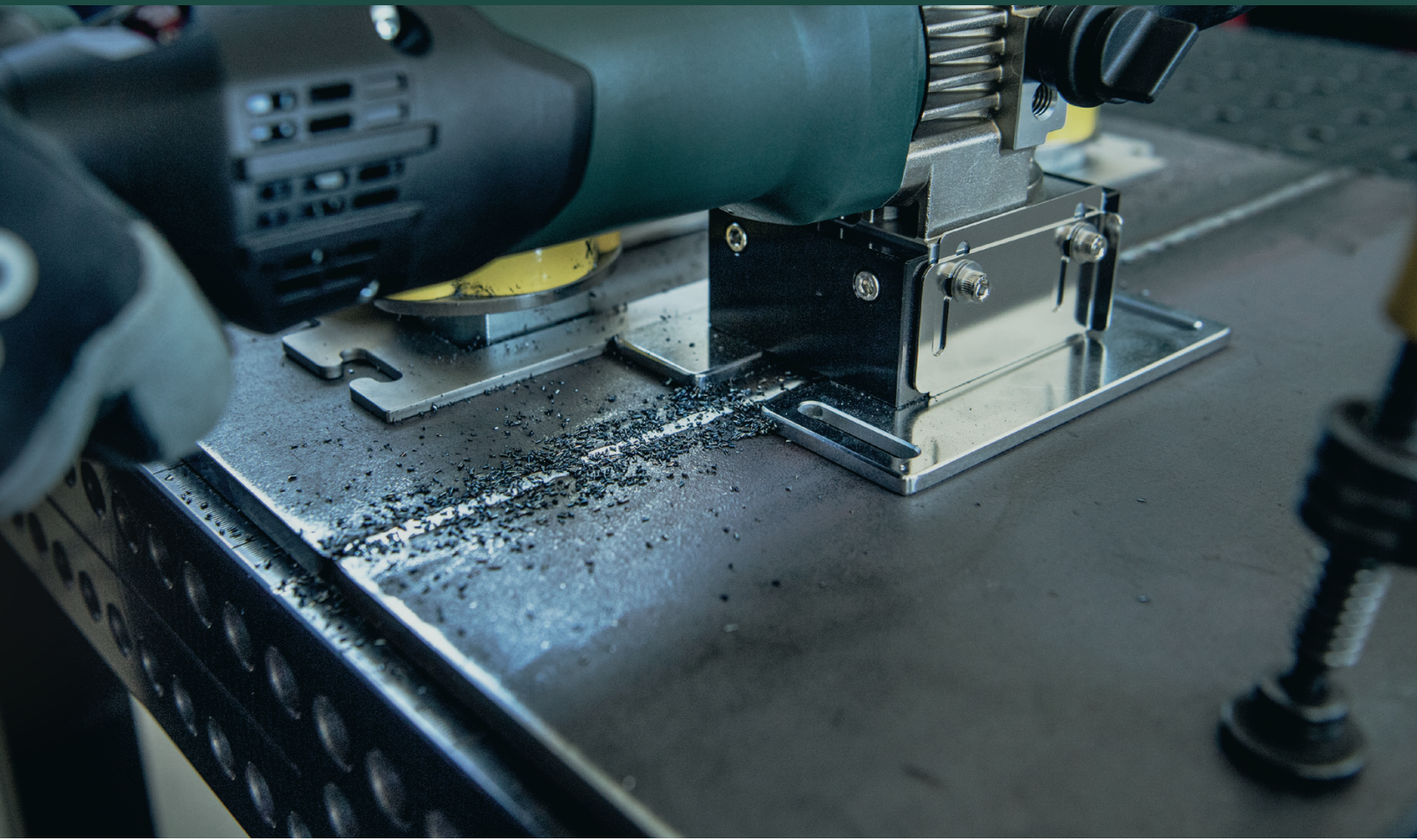

Chamfering, rounding and finishing



Edges may require a chamfer or radius to finish the job. Metabo's range of beveling tools are the perfect solution, allowing the user to set a precise depth setting and complete the surface with a smooth finish. A complete line of finishing tools that can take metal from a basic state to a mirror finish in no time are also available. Metabo has corded and cordless tools such as; burnishers, which provide in-line finishing, fillet weld grinders to reach into tight corners, pipe/tube sanders to finish rounded surfaces, band files for finishing both external and internal surfaces, and polishers that provide the final shine.

Installation



With Metabo's full range of cordless German engineered tools, you can size, drill, tap, rivet, install, fasten and mount work wherever you are working, even in remote areas. Safety is enhanced with the elimination of extension cords or air lines. Metabo's industry-leading LiHD battery technology assures power and runtime to get the job done quickly and safely.

Boost performance with "The Metabo System"

For Highest Performance, Productivity and Safety: Pair Metabo Angle Grinders and Abrasives

"Quick" Tool-free
Wheel Change System



M-QUICK

**Mechanical
Safety
Clutch**
Reduces the
likelihood of
kickback



S-AUTOMATIC
MECHANICAL
SAFETY CLUTCH



**Speed Control
Electronics**
+
User Safety Protections
+
Overload Protection

**Most Powerful
LongLife Motor**

LONGLIFE
MOTOR

**Drop Secure
Ring**



DROP SECURITY
RING

**Safety
Paddle Switch**

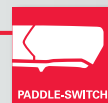

PADDLE-SWITCH

**M-BRUSH
TECHNOLOGY** 3X Carbon brush
life time



FAST BRAKE

**Most Reliable and Unique
Mechanical Brake System**

**50% Vibration
Reduction System**



AUTOBALANCER

MADE IN GERMANY

*Individual features depending on angle grinder model.

The Right Grinder for the Job

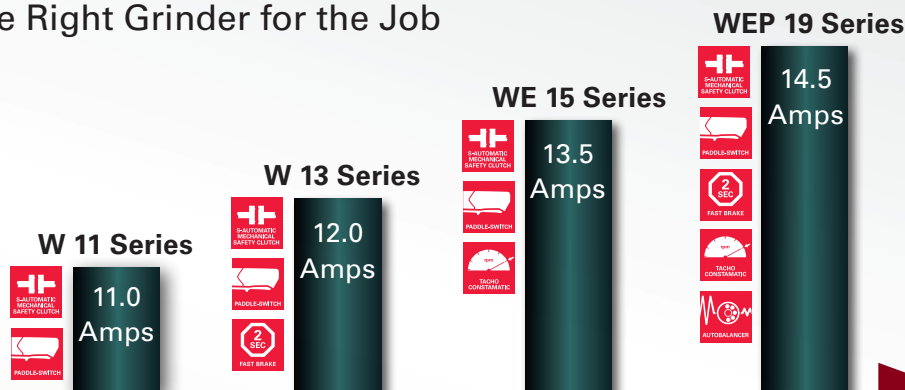

HEAVY DUTY

SUPER DUTY

EXTREME DUTY

Boost performance with "The Metabo System"

For Highest Performance, Productivity and Safety: Pair Metabo Angle Grinders and Abrasives

HEAVY DUTY

Fast and reliable results

SUPER DUTY

Longer life, improved productivity

EXTREME DUTY

Unstoppable, unmatched productivity

Original

Plus

Ceramic

Original Slicer

Fast, cool cutting,
burr free



Slicer Plus

Fast cutting,
long life,
most versatile



Ceramic M-Calibur

Extremely fast,
longest life,
toughest
conditions,
lowest total cost



Original Grinding

High removal rate



Plus-Z Grinding

Aggressive high stock
removal rate,
long life,
cool grinding,
most versatile



Ceramic M-Calibur

Extreme removal,
longest life,
lowest total cost

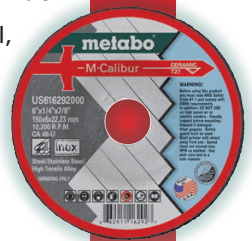

Original Flapper

Fast stock removal,
one step blending
and finishing



Flapper Plus

Aggressive stock
removal,
long life,
most versatile,
one step blending
and finishing,
cool grinding



Ceramic Flapper

High performance,
cool grinding
and finishing



Cutting

Material Removal & Finishing

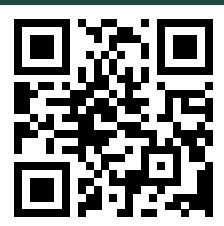

Scan to learn more
about Metabo
safety features

metabo®

PROFESSIONAL POWER TOOL SOLUTIONS

WELD SEAM PREP AND BEVELING

NEW

NEW



Beveling Tool
KFM 16-15 F
#601753620
(5/8" capacity at 45°)



Power	1,550 W / 14 A
No-load speed	12,000 RPM
Max. bel height at 45°	5/8"



7" Angle Grinder
WEPB 24-180 MVT
#606478420

7" Angle Grinder
WP 24-180 MVT
#606485420
*features depending on model



Power	2,400 W / 15 A
No-load speed	8,450 RPM
Max wheel dia.	7"



9" Cordless Angle Grinder
WPB 36-18 LTX BL 24-230
#613104830



Battery voltage	36V (2 x 18V)
No-load speed	6,600 RPM
Max wheel dia.	9"

CHAMFERING AND ROUNDING - CORDED AND CORDLESS SOLUTIONS



Chamfering Radius Beveling Tool
KFM 9-3 RF
#601751750



Power	900 W / 8.0 A
No-load speed	4,500-11,500 RPM
Max. chamfer height at 45°	1/4"



10,000-30,500 RPM Paddle Switch Die Grinder
GE 710 Plus #600616420



Power	710 W / 6.4 A
No-load speed	10,000-30,500 RPM
Collet chuck bore	1/4"



4 1/2" / 5" Angle Grinder with Non-locking Paddle Switch
WP 13-125 Quick #603629420



Power	1100 W / 12.0 A
No-load speed	11,000 RPM
Max wheel dia.	4-1/2" / 5"



LiHD
TECHNOLOGY

18V Chamfering Radius Beveling Tool
KFM 18 LTX 3 RF
#601754750 (2 x 5.5 Ah)
#601754840 (BARE)



Battery voltage	18V
No-load speed	7,000 RPM
Max. chamfer height at 45°	5/32"



25,000 RPM 18V DC Die Grinder with Non-locking Paddle Switch
GPA 18 LTX #600621860 (BARE)



Battery voltage	18V
No-load speed	25,000 RPM
Collet chuck bore	1/4"



NEW

4-1/2" / 5" 18V Brushless Non-locking Paddle Switch Angle Grinder with Brake
WPB 18 LT BL 11-125 Quick
#613059520 (2 x 5.5Ah)
#613059830 (BARE)

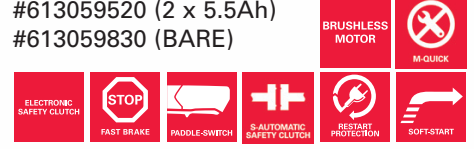

Battery voltage	18V
No-load speed	10,000 RPM
Max wheel dia.	4-1/2"

Fast and Safe Beveling

Patented One-Touch Controller

- Tool free depth adjustment
- Unmatched precision
- Locked in depth settings

13A / 1500 Watt LongLife Motor
- With integrated dust protection

Front Handle

- Tool free adjustable front handle

Deadman Switch and Safety Brake



Bevel Angle Adjustment

- Easy adjustment from 0° - 90°

Roller Guide for pipe beveling

- Increases precision for pipe beveling

Universal Cutter Head

- No need for multiple heads/cutters

Large Guide Plates

- Perfect control for plate beveling



KFMPB 15-10 F
#601755620
(3/8" capacity at 45°)

KFM 15-10 F
#601752620
(3/8" capacity at 45°)

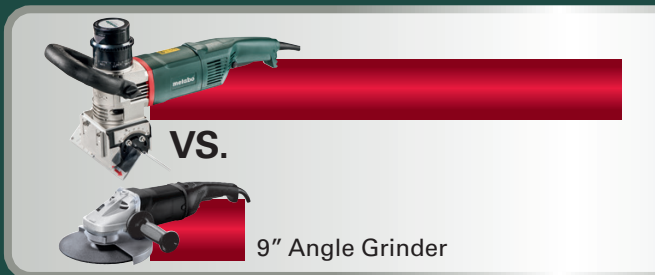

5X MORE EDGES PROCESSED IN THE SAME PERIOD OF TIME

INFINITELY ADJUSTABLE GUIDE PLATES QUICKLY ADJUST, SAVING TIME AND MONEY

- One cutter head for all bevel angles 0 - 90°
- No additional cutter heads required to achieve multiple angles
- Infinitely adjustable

PRECISE CHAMFER ANGLES = OPTIMUM WELDING CONDITIONS

More precise than an angle grinder

- Creates clean surfaces without burrs, oxidation or blue discoloration due to heat generation
- The large surface guide plates maintain uniform chamfer angles and depth

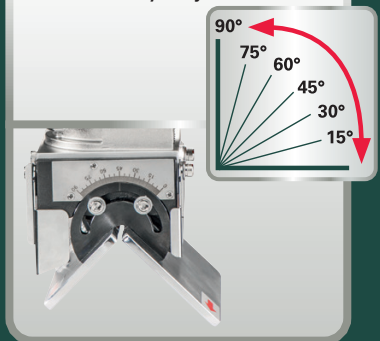
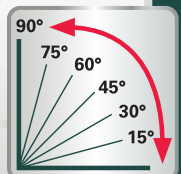

GRINDING, CUTTING, AND WELD REMOVAL

NEW



18V 6" Brushless Paddle Switch Angle Grinder with Brake
 WPB 18 LT BL 11-150 Quick
 #601737620 (2 x 5.5 Ah)
 #601737830 (BARE)



Battery voltage	18V
No-load speed	10,000 RPM
Max wheel dia.	6"



7" Angle Grinder with Drop Secure and Brake
 WEPB 19-180 RT DS
 #601096420



Power	1750 / 15.0 A
No-load speed	8,200 RPM
Max wheel dia.	7"



9" Electronic Angle Grinder with Brake
 WEPB 24-230 MVT
 #606479420



Power	2400 / 15.0 A
No-load speed	6,600 RPM
Max wheel dia.	9"



NEW

Electronic 4-1/2" / 5" Angle Grinder with Non-locking Paddle Switch, Brake, Auto-balancer, and M-Brush technology
 WEPBA 19-125 Quick DS M-Brush
 #613114420

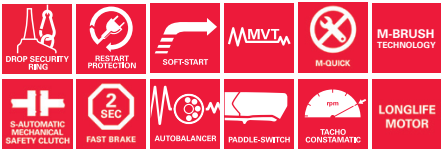

Power	1900 W / 14.5 A
No-load speed	11,000 RPM
Max wheel dia.	5"



NEW

Electronic 6" Angle Grinder with Non-locking Paddle Switch, and M-Brush technology
 WEP 19-150 Quick M-Brush
 #613111420



Power	1900 W / 14.5 A
No-load speed	9,600 RPM
Max wheel dia.	6"



NEW

Electronic 6" Angle Grinder with Non-locking Paddle Switch, Brake, Auto-balancer, and M-Brush technology
 WEPBA 19-150 Quick DS M-Brush
 #613117420



Power	1900 W / 14.5 A
No-load speed	9,600 RPM
Max wheel dia.	6"

3x

SERVICE LIFE FOR CARBON BRUSHES

Scan QR Code to learn more about



Fast, clean and safe removal of weld beads



Electronic Soft Start

One touch depth control
Patented, tool-free setting of cutting depth in 0.1 mm / .004" increments

Rat-Tail Design

For best control and handling

Bow handle

Can be adjusted without tools for reliable control



Non-locking switch

Simple and easy switch of indexable carbide inserts on cutter head



Vario-Tacho-Constamatic (VTC)-Full Wave Electronics

Maintains speed even under load. Variable speed for working in different Materials (i.e. Stainless Steel; refer to owners manual)

Scope of Delivery includes:

Magnetic guide rail, (3) indexable carbide inserts (Steel #623564000), sturdy blow-molded plastic carrying case

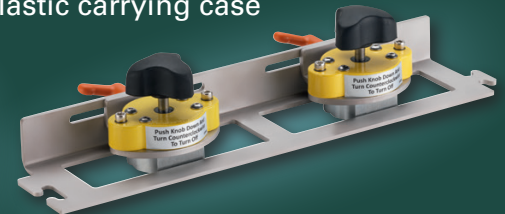

Model

PFM 17

Order number	601789620
Amps	14.5
No-load speed	8,000 - 12,600 RPM
Max. bead width	9/16"
Max. bead height	-1/16" to 3/8"
Depth setting increments	0.004"

Also available:



High chromium stainless steels (623565000)



Aluminum (623564000)

SOLD SEPARATELY



The Solution for Tight Spaces

6" Flat Head Paddle Switch
Electronic Angle Grinder with Brake
WEPBF 15-150 Quick

#613085420



Ergonomic Design
Reduces fatigue, even when working on weld joints in difficult positions

Up to 70% faster than traditional fillet weld methods



Specifically designed abrasive accessories allow the flat head grinder to work faster, saving time and money

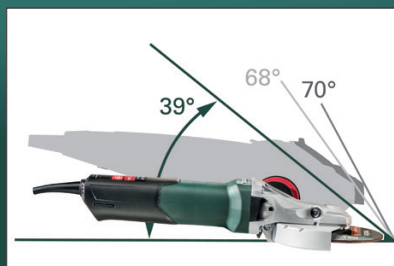

Patented gear design: the Metabo flat head angle grinder vs. standard angle grinders

Patented Gear Drive
Allows for a very low profile head design that enables grinding in angles as small as 39°, and into narrow spaces as low as 2-5/8" high with integrated dust protection

Power	1550 / 13.5 A
No-load speed	9,600 RPM
Minimum clearance	39° / 2-5/8"



18V 4-1/2" / 5" Flat Head Paddle Switch Cordless Angle Grinder
WPF 18 LTX 125
#US613070620 (2 x 8.0 Ah)
#613070860 (BARE)



Battery voltage	18V
No-load speed	8,000 RPM
Max wheel dia.	5"



6" Flat Head Angle Grinder
WEF 15-150 QUICK
#613083420

Power	1550 / 13.5 A
No-load speed	9,600 RPM
Minimum clearance	39° / 2-5/8"

UNMATCHED SAFETY



Typical problem...Grinder doesn't reach

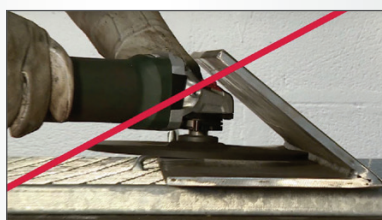

Typical solution violates safety standards



THE SAFE SOLUTION!
Metabo Flat Head Grinders

FINISHING METALS - CORDED AND CORDLESS SOLUTIONS

From a mill finish to a #8 mirror finish - and anything in between!

Grinds/finishes weld seams in tight and hard to reach places



18V Burnisher
S 18 LTX 115
#600154850 (BARE)

Variable Speed Burnisher
SE 17-200 RT
#602259620

**18V Fillet Weld
Grinder/Finisher**
KNS 18 LTX 150
#600191850 (BARE)

**Fillet Weld
Grinder/Finisher**
KNSE 9-150 # 602265620

Power 18V
RPM 3,000

Power 1750 W / 14.5 A
RPM 800-3,000

Power 18V
RPM 3,800

Power 950 W / 8.5 A
RPM 900-3,800



For reworking and polishing mounted handrails and pipes

Band file grinds, burnishes and deburrs in difficult to reach places



**18V 2-1/4" Pipe / Tube
Sander**
RB 18 LTX 60
#600192850 (BARE)

**7" Variable Speed Pipe/Tube
Sander (corded)**
RBE 15-180 Set
#602243620

18V Band File
BF 18 LTX 90
#600321850 (BARE)

8.5 A Band File (corded)
BFE 9-20
#602244620



Power 1550 W / 13.5 A
Speed 1650-5512 ft/min



For smooth processing of stainless steel, adjustable for cool finishing

Grinds in difficult to reach places

For fine grinding and high-gloss polishing of stainless steel and stone surfaces



**4-1/2" / 5" Variable Speed Angle
Grinder**
WEV 17-125 Quick Inox
#600517420

**4 1/2"-5" Flat Head
Electronic Variable Speed
High Torque Angle Grinder**
WEVF 10-125 Quick INOX
#613080420

7" Variable Speed Angle Polisher
PE 15-30
#615300420



Power 1550 W / 14.5 A
No-load speed 2000-7600 RPM



Power 1000 W / 9.5 A
No-load speed 2000-7600 RPM



Power 1550 W / 13.0 A
No-load speed 800-3000 RPM

Fastening



18V 1/4" Brushless Impact Driver
 SSD 18 LTX 200 BL
 Kit: 2 x 4.0 Ah LiHD #602396520
 BARE: #602396890

Battery voltage	18V
12-Speed	0-1,000 / 0-1,850 / 0-2,500 RPM
Torque	664 / 1062 / 1,328 in. lbs
Impacts/min.	3,300

Fastening



18V Brushless High Torque 1/2" Impact Wrench
 SSW 18 LTX 400 BL
 Kit: 2x 4.0 Ah LiHD #US602205310
 Kit: 2 x 5.5 Ah LiHD #US602205550
 BARE: #602205890

Battery voltage	18V
No-load speed	0-2,150 RPM
Torque	295 in. lbs
Impacts/min.	4,250

High Speed Drilling/Driving



NEW

3 SPEED

18V 1/2" Brushless Drill/Driver
 BS 18 LTX-3 BL I Metal
 Kit: 2 x 5.5 Ah LiHD #603180620

BRUSHLESS MOTOR	Up to 4,000 RPM!
Battery voltage	18V
3-Speed	0-450 / 0-2,000 / 0-4,000 RPM
Torque	1,150 in. lbs

Sizing/Fitting



18V Reciprocating Saw
 SSE 18 LTX BL Compact
 BARE #602366840

RESTART PROTECTION	Battery voltage	18V
	No-load speed	0-3,000 RPM
	Saw blade stroke	5/8"

Tapping/Threading



NEW

2 in 1: Push pull tapping tool, 5/8" max. thread capacity
Brushless Drill / Driver
 GB 18 LTX BL Q I
 BARE #602362840

ELECTRONIC SAFETY CLUTCH	QUICK	BRUSHLESS MOTOR	IMPULSE	PRECISION STOP
Battery voltage	18V			
2-Speed	0-550 / 0-2,000 RPM			
Torque	1,151 in. lbs			
Settings	11			

Cutting & Grinding



NEW

18V 4-1/2" Brushless Paddle Switch Angle Grinder with Brake
 WPB 18 LT BL 11-150 Quick
 #601737620 (2 x 5.5 Ah)
 #601737830 (BARE)

BRUSHLESS MOTOR	ELECTRONIC SAFETY CLUTCH	S-AUTOMATIC SAFETY CLUTCH	PADDLE SWITCH	M-QUICK	RESTART PROTECTION
Battery voltage	18V				
No-load speed	10,000 RPM				
Max wheel dia.	4-1/2"				

Anchoring



1-1/8" SDS-Plus Combination Hammer with Dust Extraction
 KH 18 LTX BL 28 Q + ISA 28
 BARE #600211900

NEW	
VARIO TACHO CONSTAMATIC	SOFT-START
QUICK	BRUSHLESS MOTOR
S-AUTOMATIC MECHANICAL SAFETY CLUTCH	MVVT
VARIO CONSTAMATIC	
Battery voltage	18V
No-load speed	0-1,000 RPM
Impacts/min.	4,470

Riveting

Up to 3/16" Rivets in aluminum!



BRUSHLESS MOTOR	Battery voltage	18V
	Capacity	3/16" steel, 1/4" alum.
	Force	10kN



MADE IN GERMANY

Angle Grinder

SAFETY Training

Angle Grinder Usage requires CAUTION

Thousands of angle grinder-related injuries are reported each year - injuries that could have been prevented.

Why do Accidents Happen?

- 1 - Fatigue
- 2 - Rushing to finish a job
- 3 - Lack of awareness of the potential risks
- 4 - Use of the wrong tool or wrong accessories
- 5 - Removal or bypassing the tools safety features

Accidents Happen... FAST!

A 6" thin cutting wheel has a no-load speed of 9,600 RPM, which equals

170 MPH!

45^{MIN}
SESSIONS

SCHEDULE TODAY!

"8 Steps To A Safer Work Place"

To schedule your safety training with our experienced team, please contact us at safety@metabousa.com.

CAUTION: SAFETY ZONE

metabo[®]
PROFESSIONAL POWER TOOL SOLUTIONS